

EE631 Cooperating Autonomous Mobile Robots

Lecture 1: Introduction

Prof. Yi Guo

ECE Department



Plan

- Overview of Syllabus
- Introduction to Robotics
 - Applications of Mobile Robots
 - Ways of Operation
 - Single Robot vs. Multi-Robots
- Research in Multi-Robot Systems
- Topics of Study This Semester

Applications of Mobile Robots

Indoor

Structured Environments

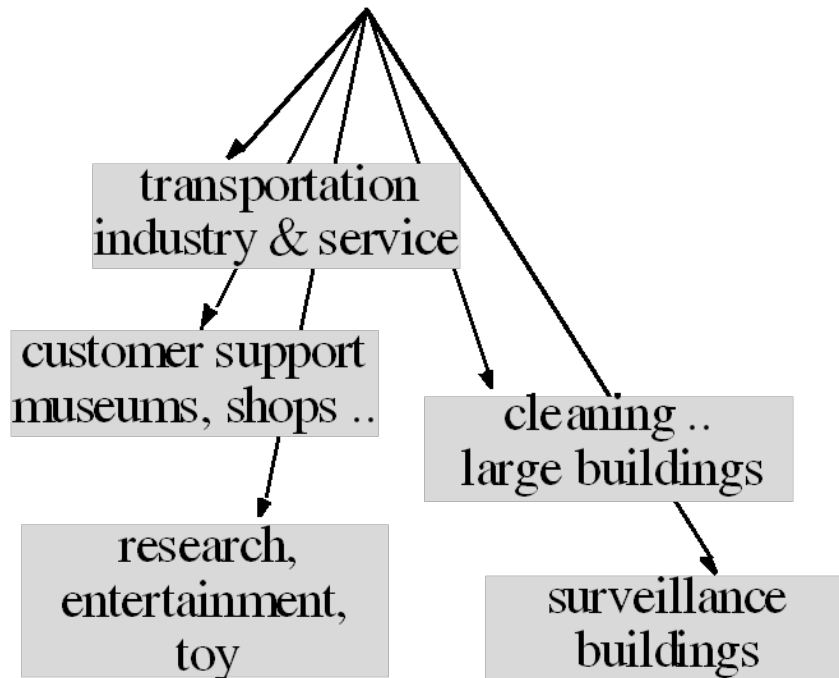

Outdoor

Unstructured Environments

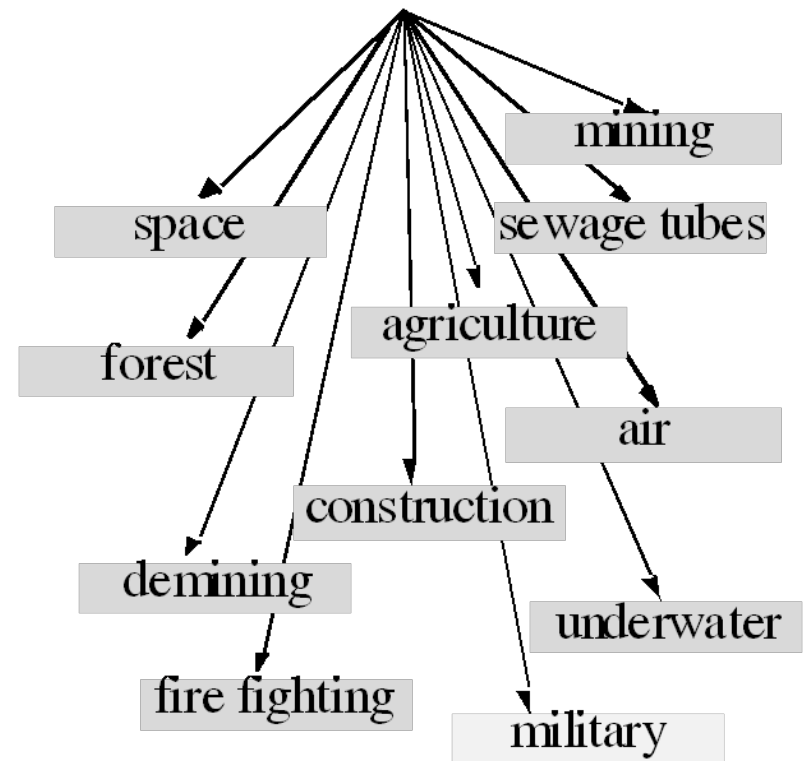

From Manipulators to Mobile

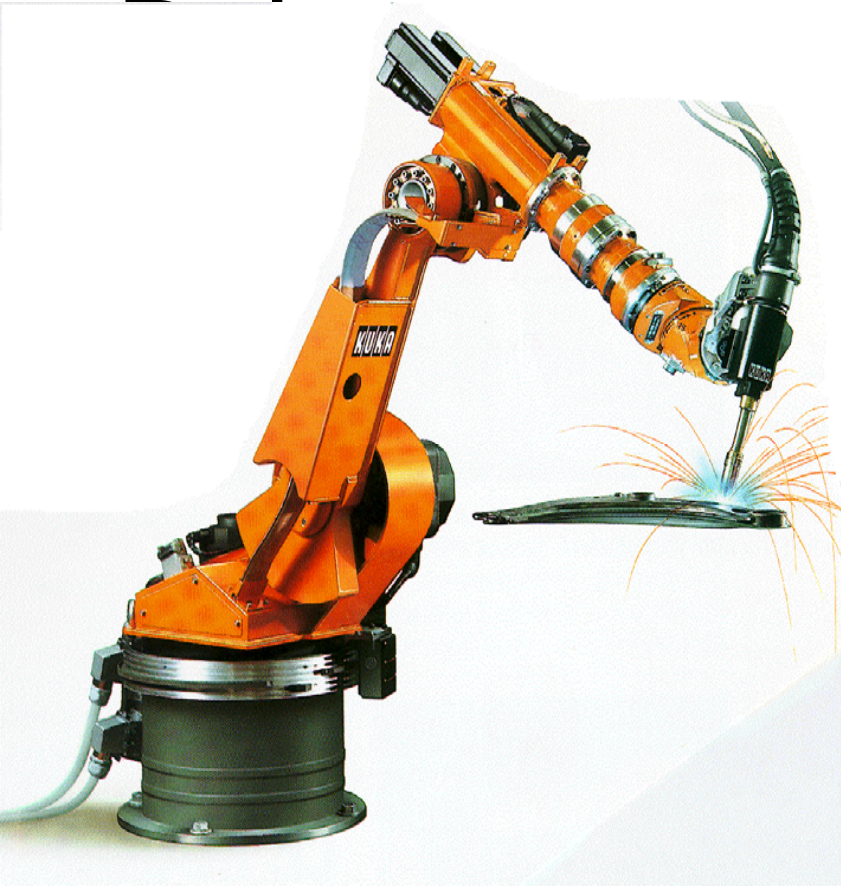

Automatic Guided Vehicles

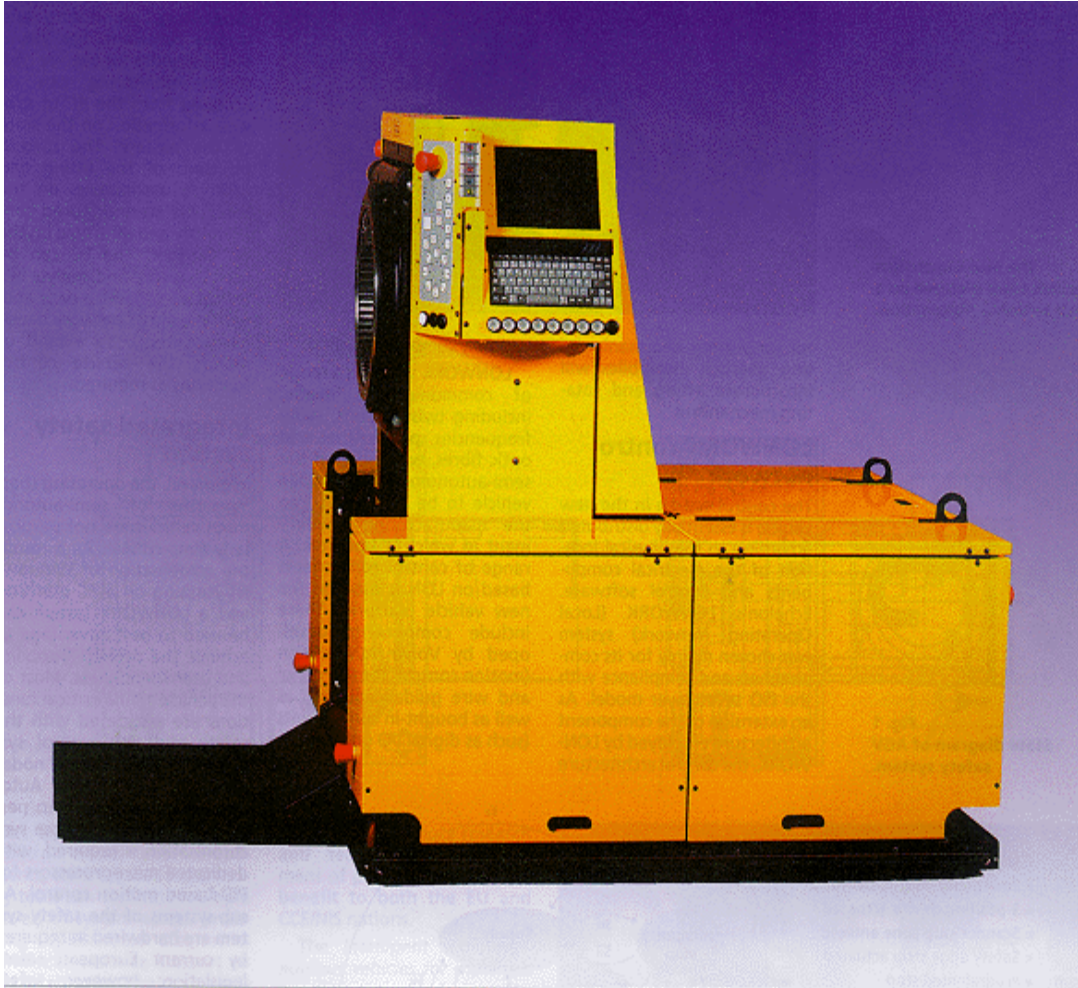

- Newest generation of Automatic Guided Vehicle of VOLVO used to transport motor blocks from on assembly station to an other. It is guided by an electrical wire installed in the floor but it is also able to leave the wire to avoid obstacles. There are over 4000 AGV only at VOLVO's plants.

Helpmate

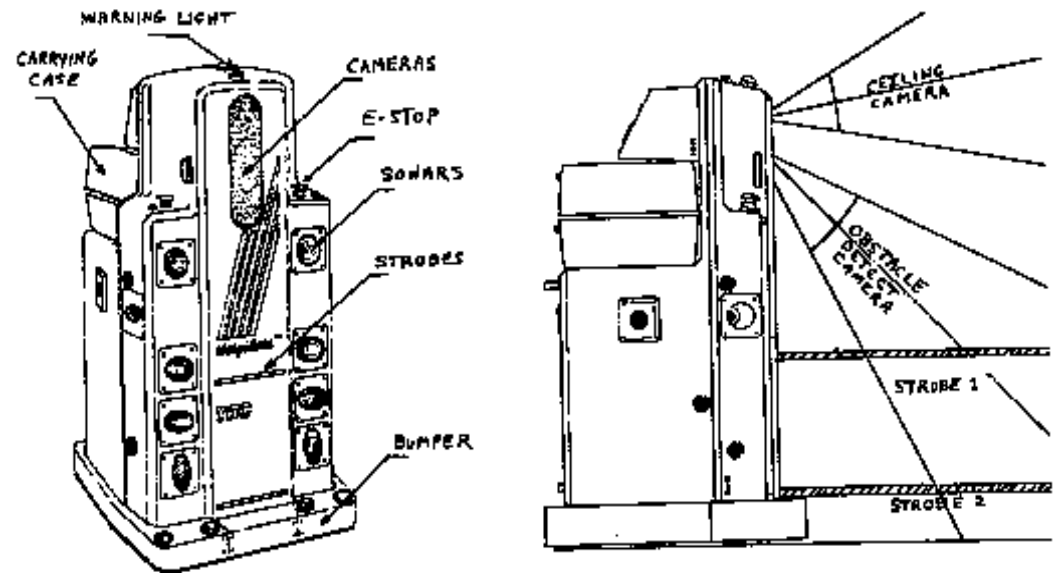
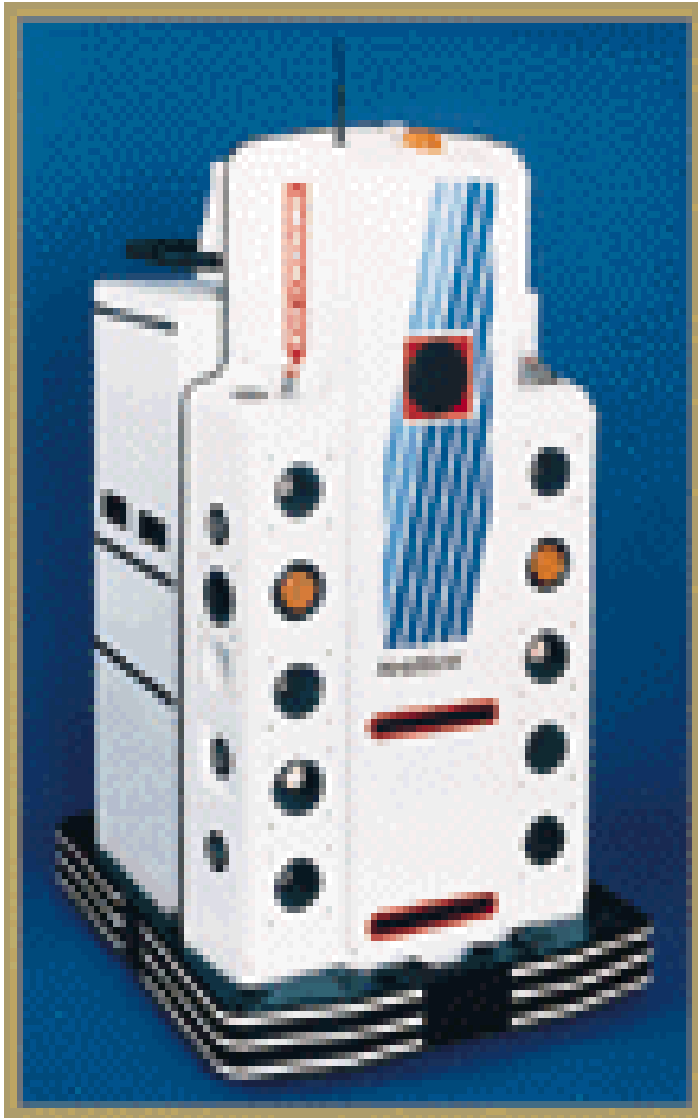

- HELPMATE is a mobile robot used in hospitals for transportation tasks. It has various on board sensors for autonomous navigation in the corridors. The main sensor for localization is a camera looking to the ceiling. It can detect the lamps on the ceiling as reference (landmark). <http://www.ntplx.net/~helpmate/>

BR700 Cleaning Robot



- BR 700 cleaning robot developed and sold by Kärcher Inc., Germany. Its navigation system is based on a very sophisticated sonar system and a gyro.
<http://www.karcher.de>

ROV Tiburon Underwater Robot

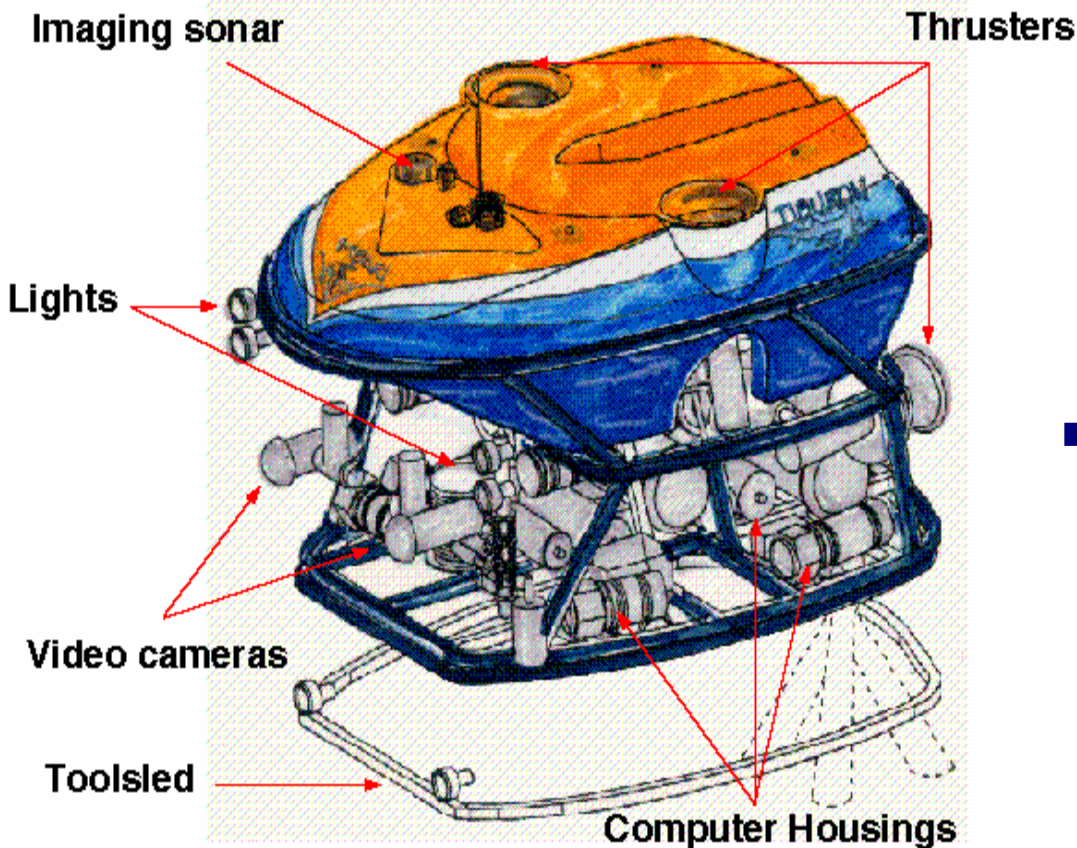

- Picture of robot ROV Tiburon for underwater archaeology (teleoperated)- used by MBARI for deep-sea research, this UAV provides autonomous hovering capabilities for the human operator.

The Pioneer

- Picture of Pioneer, the teleoperated robot that is supposed to explore the Sarcophagus at Chernobyl



The Pioneer



- PIONEER 1 is a modular mobile robot offering various options like a gripper or an on board camera. It is equipped with a sophisticated navigation library developed at Stanford Research Institute (SRI).
<http://www.activmedia.com/robots>

The B21 Robot

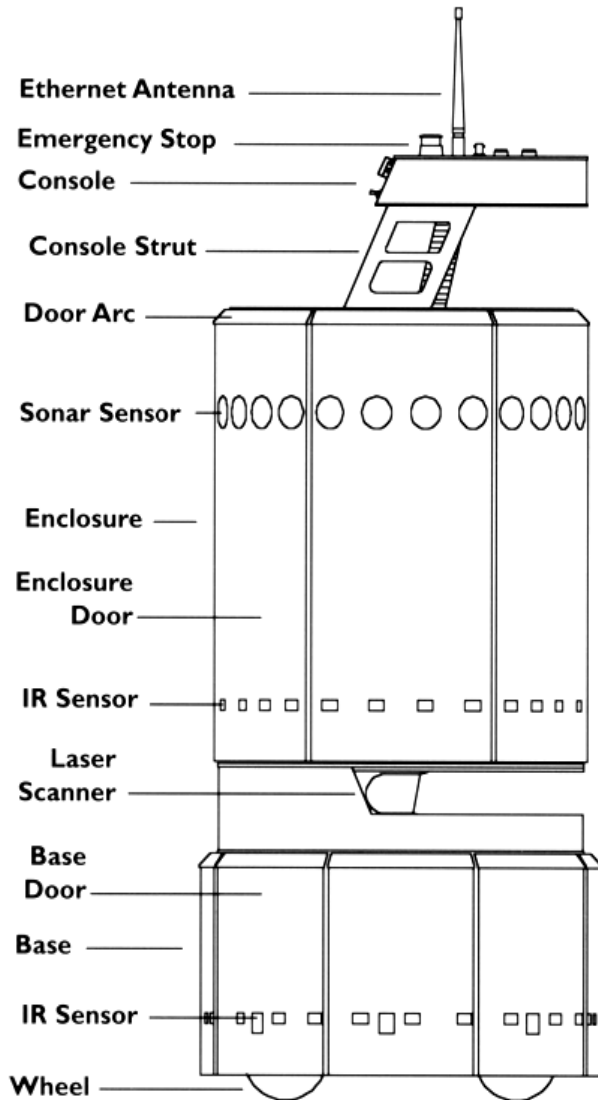

- B21 of Real World Interface is a sophisticated mobile robot with up to three Intel Pentium processors on board. It has all different kinds of on board sensors for high performance navigation tasks. <http://www.rwii.com>

The Khepera Robot

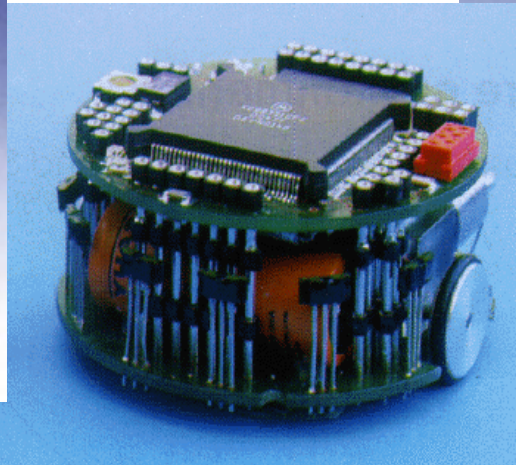
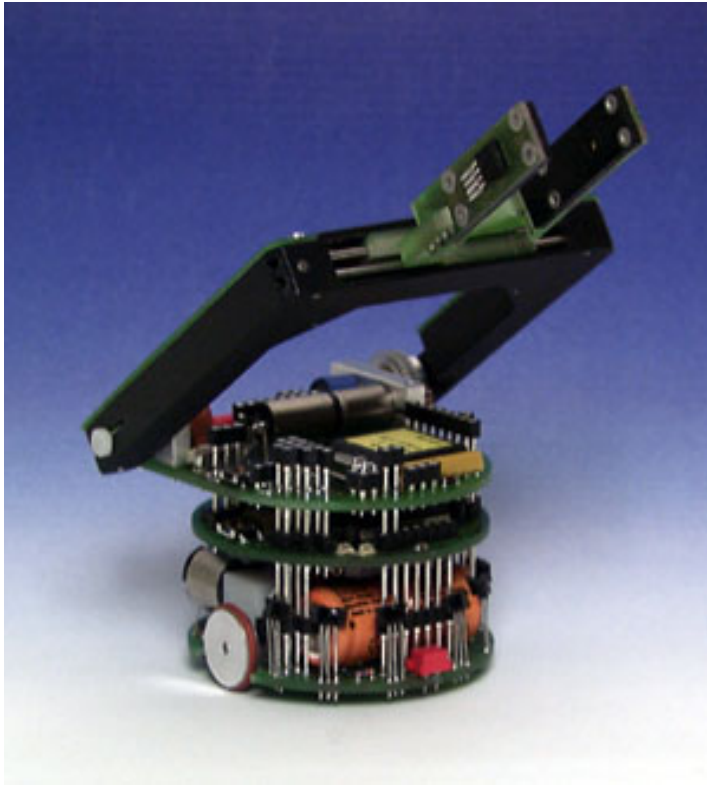

- KHEPERA is a small mobile robot for research and education. It sizes only about 60 mm in diameter. Additional modules with cameras, grippers and much more are available. More then 700 units have already been sold (end of 1998). <http://diwww.epfl.ch/lami/robots/K-family/K-Team.html>

Forester Robot



- Pulstech developed the first 'industrial like' walking robot. It is designed moving wood out of the forest. The leg coordination is automated, but navigation is still done by the human operator on the robot.
<http://www.plustech.fi/>

Robots for Tube Inspection

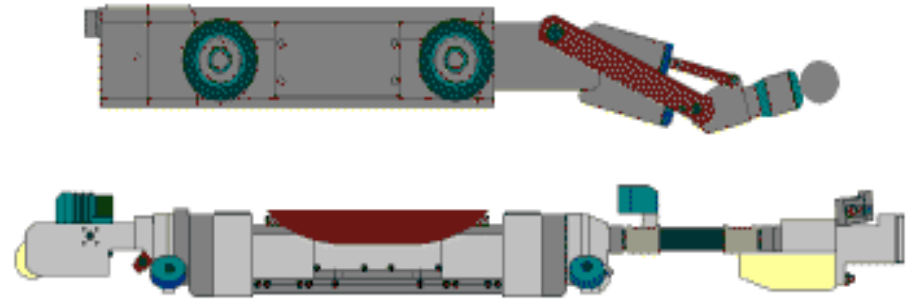

- HÄCHER robots for sewage tube inspection and repair. These systems are still fully teleoperated. <http://www.haechler.ch>
- EPFL / SEDIREP: Ventilation inspection robot

Sojourner, First Robot on Mars

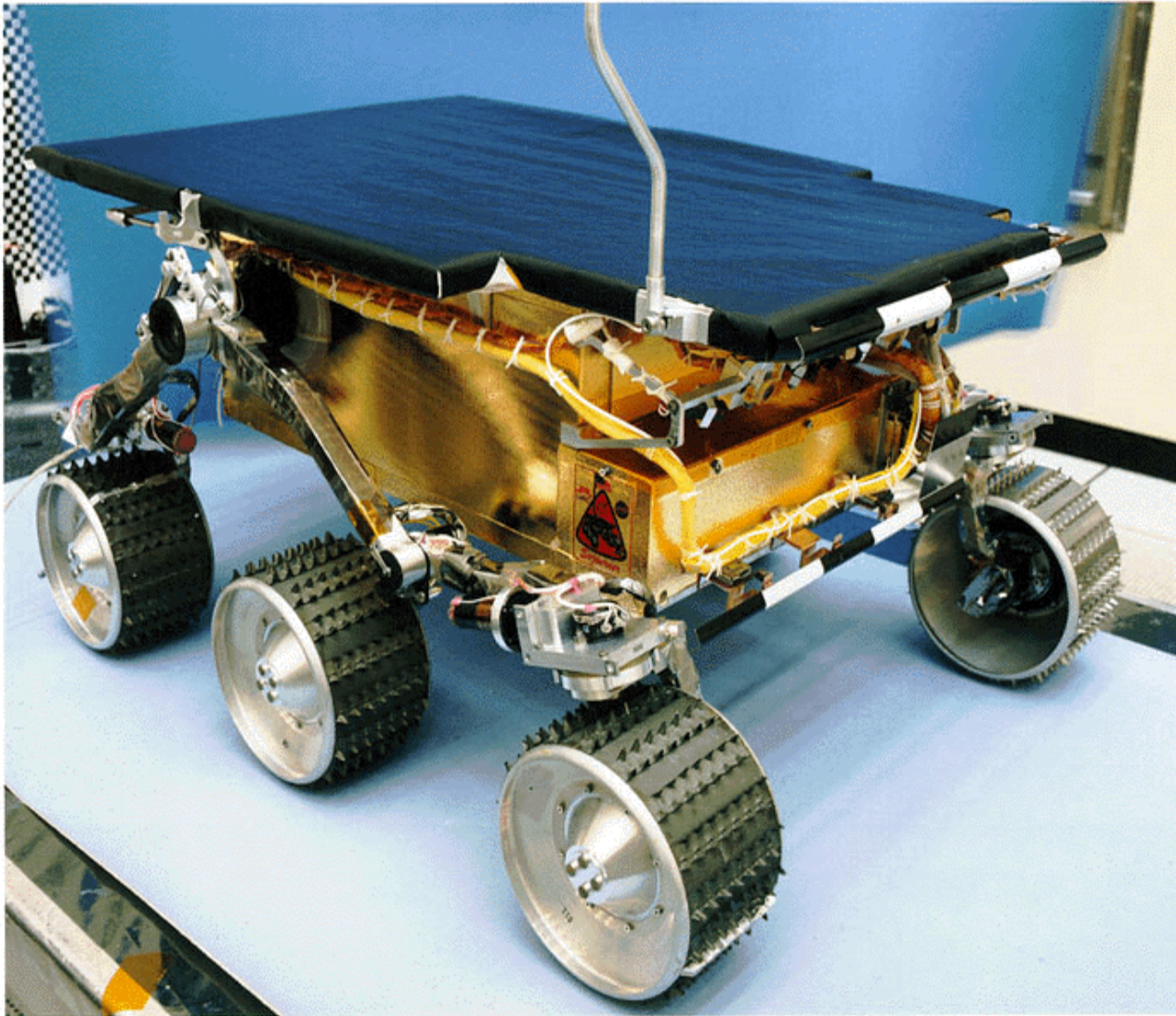

- The mobile robot Sojourner was used during the Pathfinder mission to explore the Mars in summer 1997. It was nearly fully teleoperated from Earth. However, some on-board sensors allowed for obstacle detection. http://ranier.oact.hq.nasa.gov/telerobotics_page/telerobotics.shtm

The Honda Walking Robot

<http://www.honda.co.jp/tech/other/robot.html>

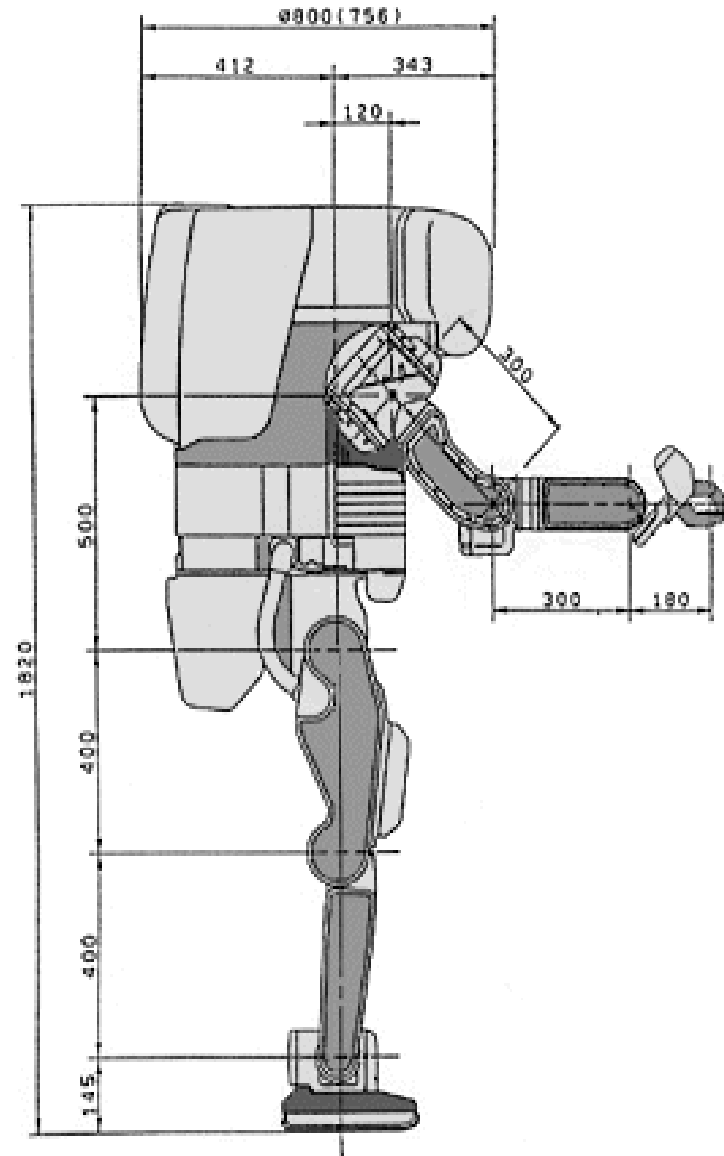
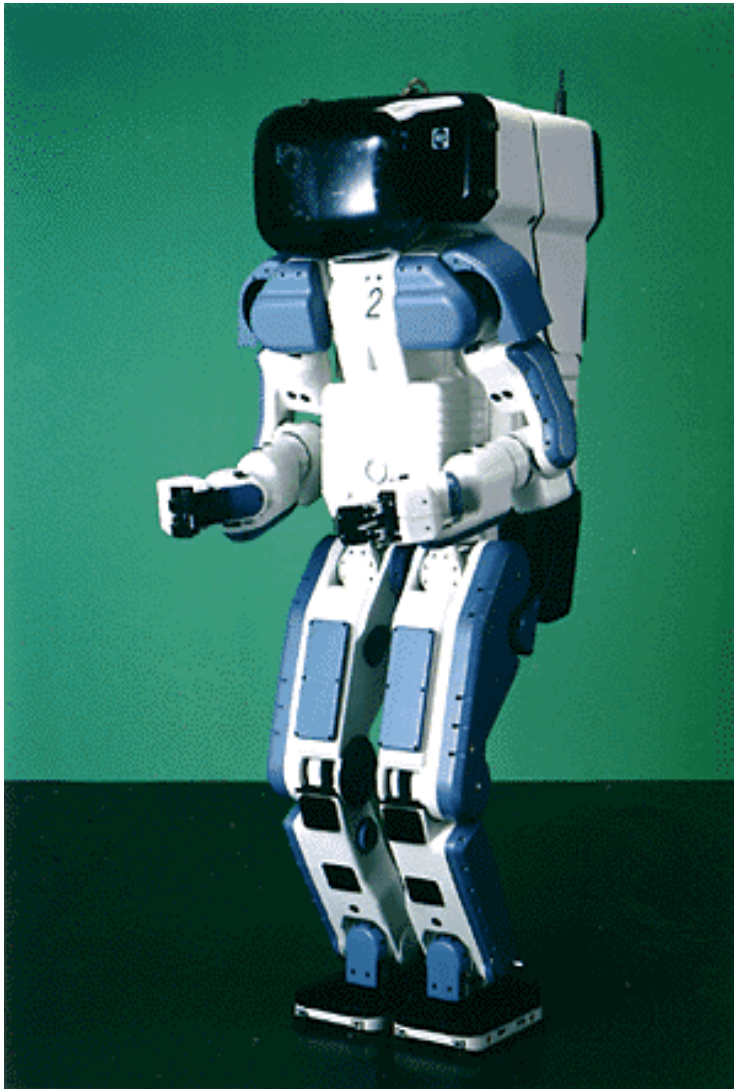

Toy Robot Aibo from Sony

- Size
 - length about 25 cm
- Sensors
 - color camera
 - stereo microphone



Humanoid Robots

- MIT AI lab: Kismet is an expressive robotic creature with perceptual and motor modalities tailored to natural human communication channels
- Equipped with visual, auditory, and proprioceptive sensory inputs. The motor outputs include vocalizations, facial expressions, and motor capabilities to adjust the gaze direction of the eyes and the orientation of the head



Future Combat Systems



- “Future Combat System is a major program for an entire System of Systems to transform the U.S. Army to be strategically responsive and dominant at every point on the spectrum of operations, through real-time network-centric communications and systems for a family of manned vehicles and unmanned platforms by the next decade”, from <http://www.rwii.com/>

Technical Activities in Robotics

Technical Committees: Spring 2006

click committee name for more information

1. [Aerial Robotics and Unmanned Aerial Vehicles](#)
2. [Agricultural Robotics](#)
3. [Bio Robotics](#)
4. [Computer & Robot Vision](#)
5. [Human-Robot Interaction & Coordination](#)
6. [Humanoid Robotics](#)
7. [Intelligent Transportation Systems](#)
8. [Manufacturing Automation](#)
9. [Micro/Nano Robots](#)
10. [Networked Robots](#)
11. [Programming Environments in Robotics & Automation](#)
12. [Prototyping for Robotics and Automation](#)
13. [Rehabilitation Robotics](#)
14. [Robo-Ethics](#)
15. [Safety Security and Rescue Robotics](#)
16. [Semiconductor and Factory Automation](#)
17. [Service Robotics](#)
18. [Surgical Robotics](#)
19. [Underwater Robotics](#)

Version: Release Candidate 3.1 - August 9, 2005



Ways of Operation

■ Teleoperation

- you control the robot
- you can only view the environment through the robot's eyes
- don't have to figure out AI



■ Teleoperation best suited for:

- the tasks are *unstructured* and *not repetitive*
- the task workspace *cannot be engineered* to permit the use of industrial manipulators
- key portions of the task require *dexterous manipulation*, especially hand-eye coordination, *but not continuously*
- key portions of the task *require object recognition or situational awareness*
- the needs of the display technology *do not exceed the limitations of the communication link* (bandwidth, time delays)
- the *availability of trained personnel* is not an issue



Ways of Operation

- Semi or fully autonomy:
 - you might control the robot sometimes
 - you can only view the environment through the robot's eyes
 - ex. Sojourner with different modes
 - human doesn't have to do everything

Ways of Operation

■ ***Semi-autonomous***

□ ***Supervisory Control***

- human is involved, but routine or “safe” portions of the task are handled autonomously by the robot
- is really a type of mixed-initiative
- **Shared Control/ Guarded Control**
 - human *initiates* action, interacts with remote by *adding perceptual inputs or feedback*, and *interrupts* execution as needed
 - robot may “protect” itself by not bumping into things
- **Traded Control**
 - human initiates action, *does not interact*



Mixed Initiative

- Levels of Initiative

- do only what told to do (teleoperation)
- recommend or augment (cognitive augmentation)
- act and report
- act on own and supervise itself (autonomy)

Single Robots vs. Multi-Robots

- Why multiple robots?
 - Tasks that are distributed (spatially, temporally, functionally)
 - Distributed sensing and action
 - Fault tolerance
 - Lower economic cost
- Cooperative behaviors (Cao *et.al.*'97):

“Given some task specified by a designer, a multiple-robot system displays cooperative behavior if, due to some underlying mechanism (i.e., the “mechanism of cooperation”), there is an increase in the total utility of the system.”



Autonomous Mobile Robot

- What is a mobile robot?
 - It can move in the real world
 - It can be completely autonomous
- What defines a mobile robot?
 - The ability to navigate
 - Think about what you need in order to navigate in a rich environment
- How difficult is the problem of navigation?
 - Depends on what you want to do

Simple Motion

- Random walk
 - Collision avoidance
 - Collision prediction
- Fixed goals
 - Go to a point or series of points
- Coverage
 - Explore or cover an area
 - Try not to backtrack too much
- Dynamic goals
 - Go to a possibly moving point
 - Specify the goal as an abstract concept

General Control Scheme

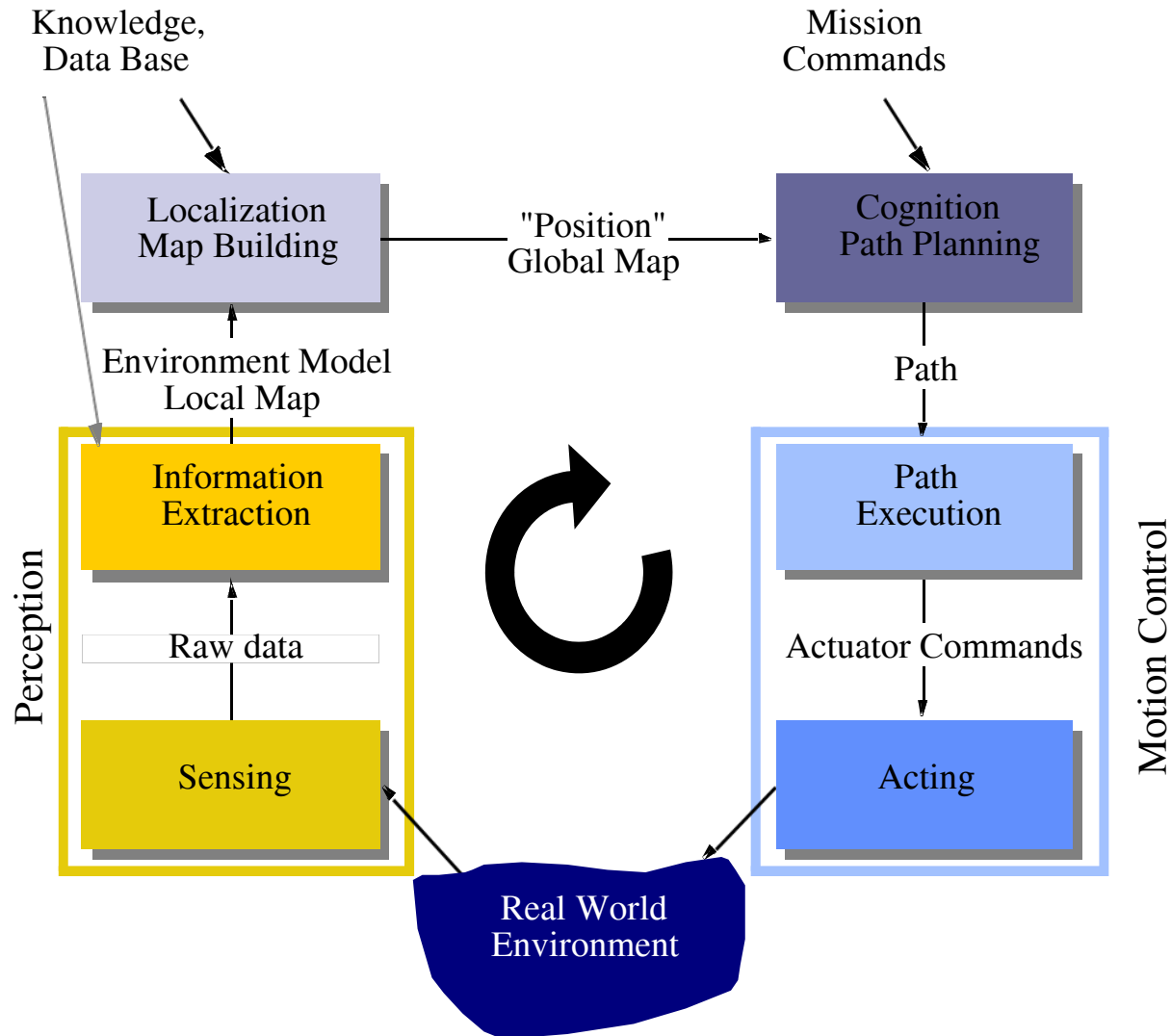

A Brief History of Robot Navigation

- Early method: sense, plan, act
 - Sensor analysis took time: attempted to build high-level representations
 - Planning was deliberate and took time
 - Actions were slow
- Reactive method: sense-decide-act
 - Simplify the sensing: use a lower level representation
 - Simplify the decision-making: use sub-symbolic or simple computation
 - Let the decision-making and analysis work in parallel
 - Combine the resulting “behaviors” in a useful way
 - Actions are much faster



A Brief History of Robot Navigation

- Combined systems:
 - Have multiple layers
 - Layer 1: behaviors reacting to sensor stimulus
 - Layer 2: combinations of behaviors and goals
 - Layer 3: high-level sensor analysis and planning

Combined systems seem to offer the most promise for real world robots



Autonomous Mobile Robots

- Subject Areas

1. Locomotion
2. Mobile Robot Kinematics
3. Perception
4. Mobile Robot Localization
5. Planning and Navigation

Application Domains of Multi-Robot Teams

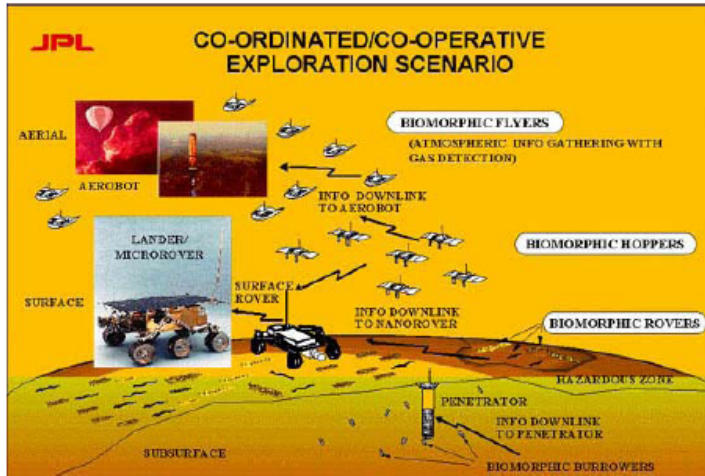

Space Exploration



Mining

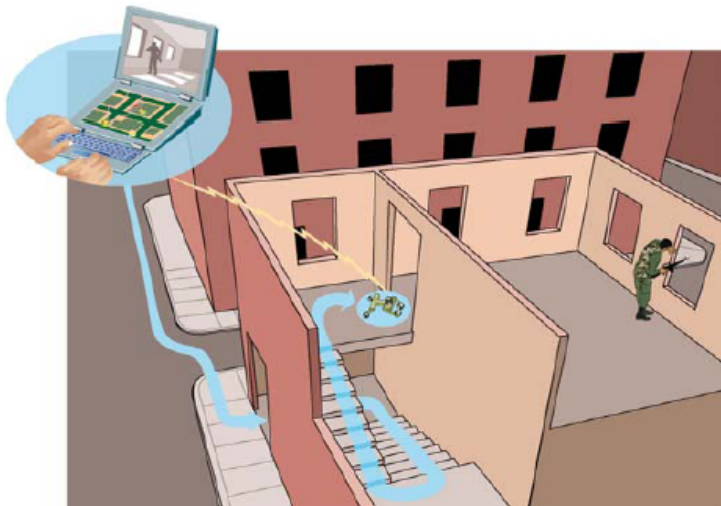

Surveillance and Reconnaissance

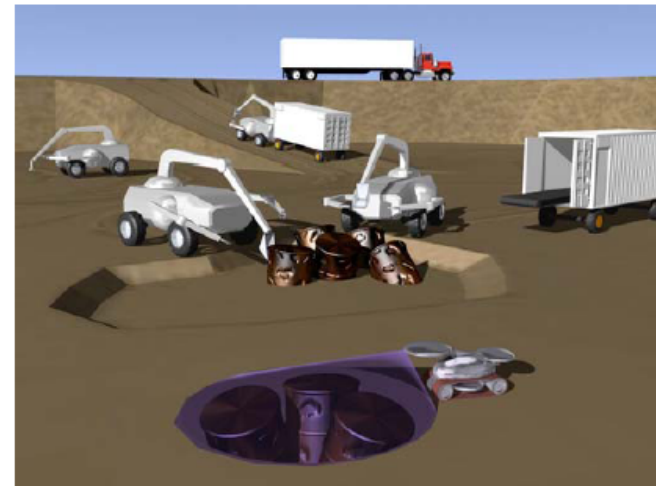

Hazardous Waste Cleanup

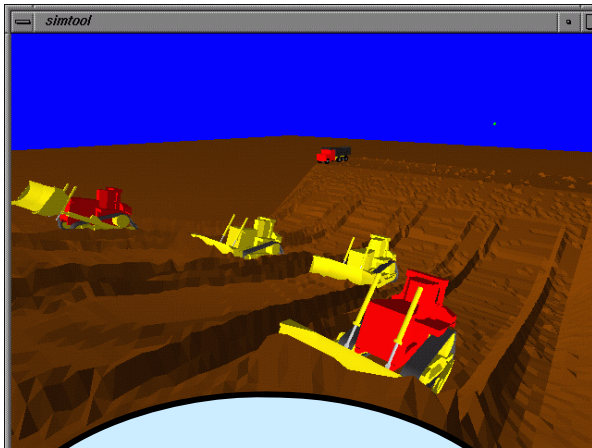

*Intelligent Systems
in Industry
Caterpillar*

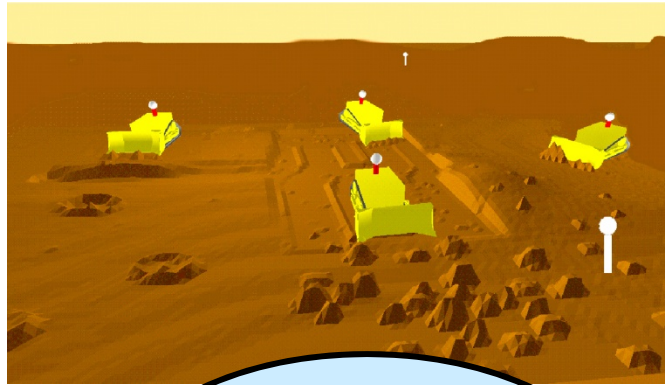

*Planetary Exploration
NASA/JPL*

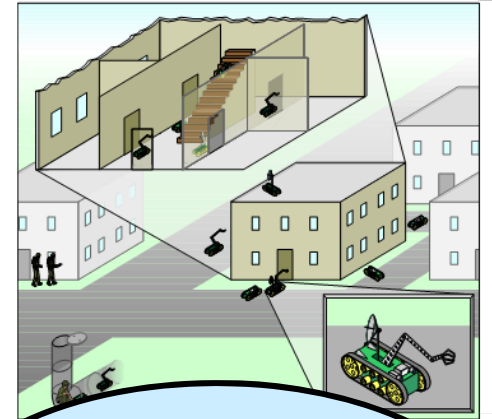

*Military Operations
DARPA
(TTO/ATO, ITO)*

*Surveillance & Security
DHS*



Research in multi-robotics growing rapidly

- Conducted an INSPEC* Search:
 - Yearly query, 1979 -2001
 - Searched for articles including at least one of the following terms:
 - Multi-robot
 - Multirobot
 - Cooperative robot
 - Collaborative robot
 - Distributed robot

* Citation index for physics, electronics, and computing

Articles in INSPEC

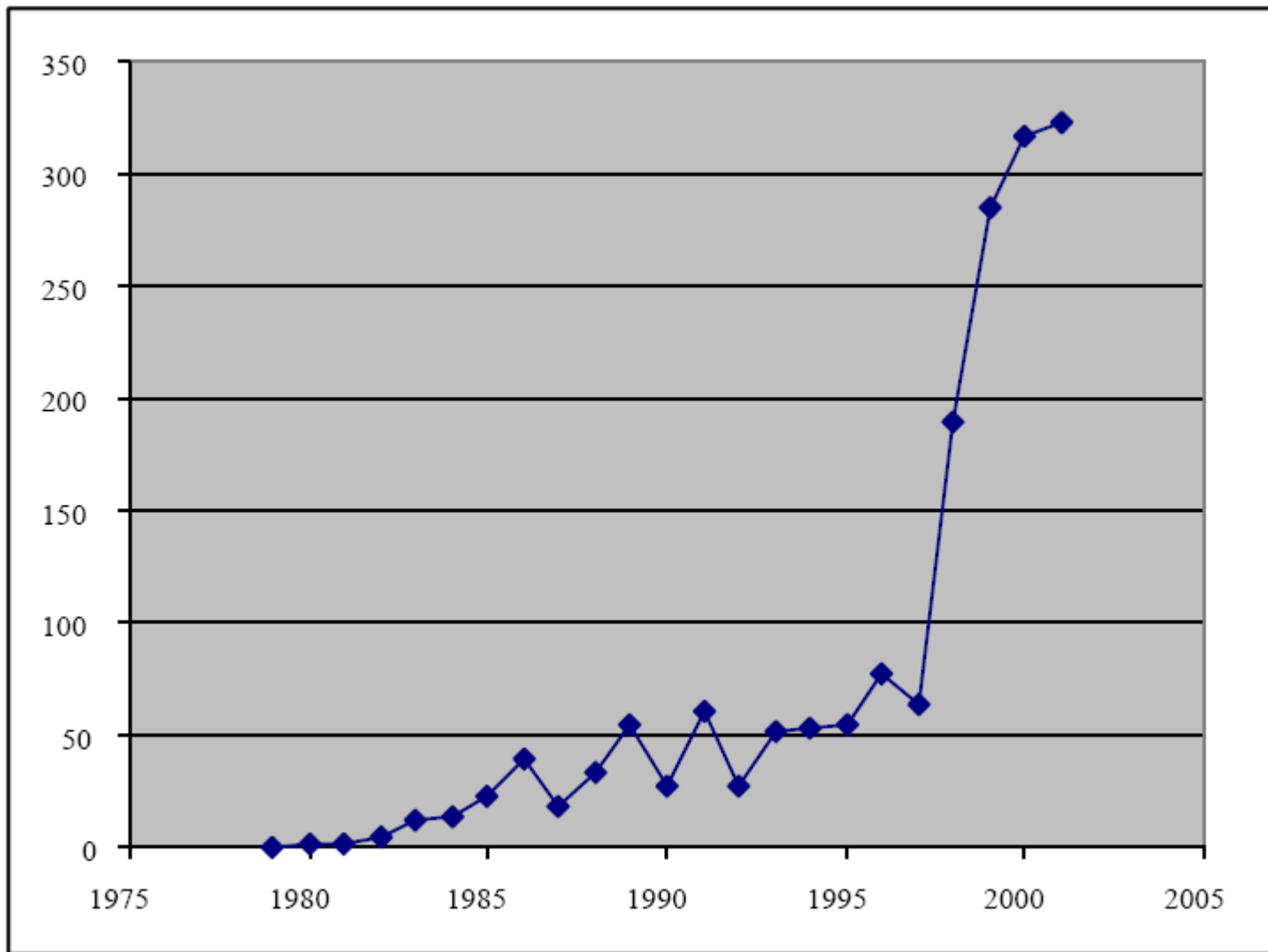



Primary Research Areas in Distributed Robotics

- Biological Inspirations
- Motion Coordination
- Communication
- Object Transport and Manipulation
- Reconfigurable Robotics
- Architectures, Task Planning, and Control
- Localization, Mapping, and Exploration
- Learning



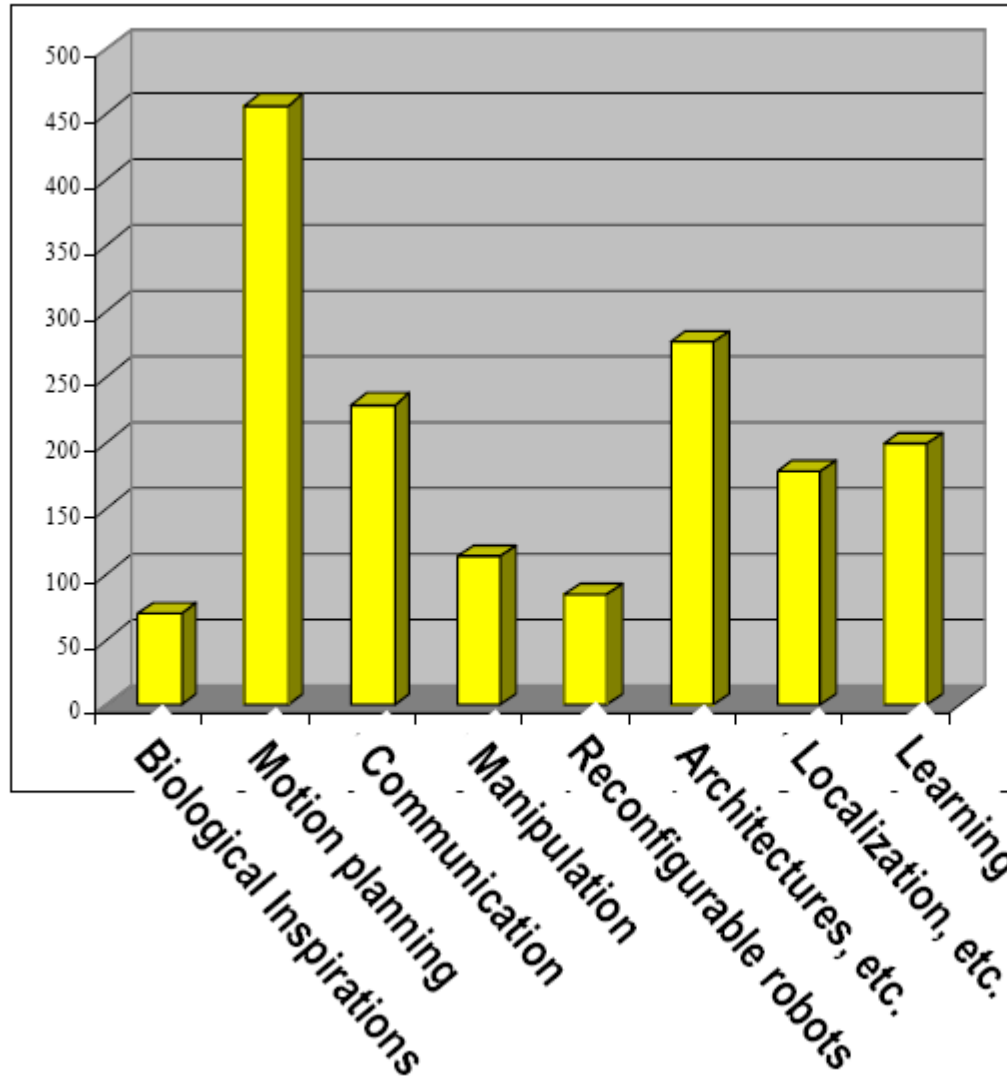







Articles in INSPEC

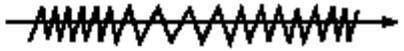

*(Values based upon
INSPEC search for
years 1979 - 2001)*

Biological Inspirations

- Locomotion Concepts: Principles Found in Nature

Type of motion	Resistance to motion	Basic kinematics of motion
Flow in a Channel 	Hydrodynamic forces	Eddies 
Crawl 	Friction forces	Longitudinal vibration 
Sliding 	Friction forces	Transverse vibration 
Running 	Loss of kinetic energy	Oscillatory movement of a multi-link pendulum 
Jumping 	Loss of kinetic energy	Oscillatory movement of a multi-link pendulum 
Walking 	Gravitational forces	Rolling of a polygon (see figure 2.2) 

■ Communication

- Auditory, chemical, tactile, visual, electrical
- Direct, indirect, explicit, implicit

■ Roles

- Strict division vs. loose “assignments”

■ Hierarchies

- Absolute linear ordering, partial ordering, relative ordering
- Purpose: reduction in fighting, efficiency

■ Territoriality

- Reduces fighting, disperses group, simplifies interactions

■ Social facilitation/sympathetic induction

- Allows for efficient use of resources

■ Imitation

- Complex mechanism for learning



Leaf cutter ants

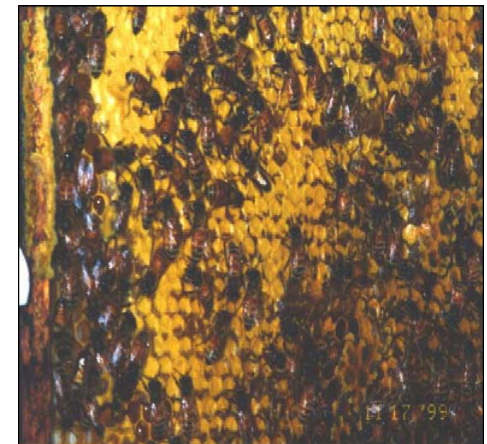

Bees colony



Biological Inspirations

- *Objective: Study biological systems to achieve engineering goals*



Motion Coordination

- Objective: enable robots to navigate collaboratively to achieve spatial positioning goals
- Issues studied:
 - Multi-robot path planning
 - Traffic control
 - Formation generation
 - Formation keeping
 - Target tracking
 - Target search
 - Multi-robot docking

Reconfigurable Robotics

- *Objective: Obtain function from shape, allowing modules to (re)connect to form shapes that achieve desired purpose*
 - Earliest research included reconfigurable/cellular robotics
 - Several newer projects:
 - Various navigation configurations (rolling track, spider, snake, etc.)
 - Lattices, matrices (for stair climbing, object support, etc.)

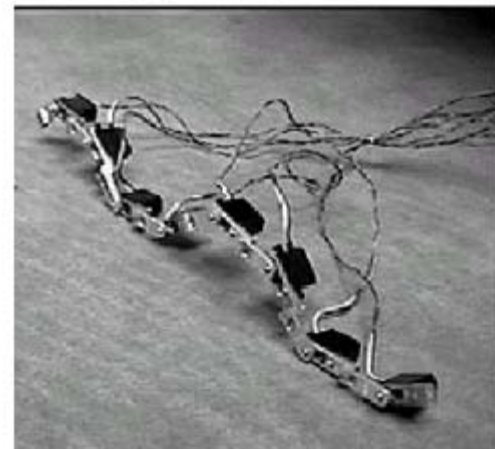
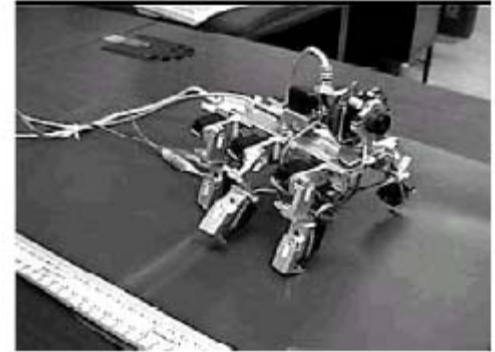

Castano et. al.

Architectures, Task Planning, and Control

- *Objective: Development of overall control approach enabling robot teams to effectively accomplish given tasks*
- Issues studied:
 - Action selection
 - Delegation of authority and control
 - Communication structure
 - Heterogeneity versus homogeneity of robots
 - Achieving coherence amidst local actions
 - Resolution of conflicts

Localization, Mapping, and Exploration

- *Objective: Enable robot teams to cooperatively build models of their environment, or to accomplish spatial tasks requiring knowledge of other robot positions*
- Issues studied:
 - Extension of single-robot mapping approach to multi-robot teams
 - Hardware, algorithms for robot positioning
 - Sonar vs. laser vs. stereo imagery vs. fusion of several sensors
 - Landmarks vs. scan-matching



Topics of Study This Semester

- Robot kinematics
- Path planning, motion planning
- Cooperative behaviors
- Formation control of robotic vehicles
- Biologically inspired robots, reconfigurable robots